

Varenummer: 20141B48B482SW
 Beskrivelse: E+G Kryds m/flange
 GN141-B48-B48-2-SW

Mål

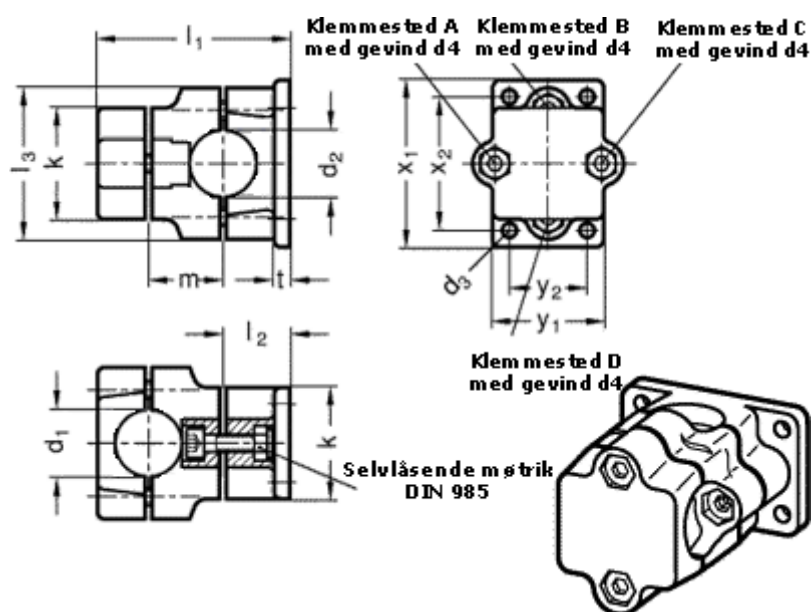

d1 = 48	m	= 55
d2 = 48	t	= 14
d3 = 11	Vippehåndtag = GN 911-M10-63 skal bestilles separat	
d4 = M10	x1	= 115
k = 76	x2	= 90
l1 = 136	y1	= 76
l2 = 46	y2	= 50
l3 = 98		